

DEPOSITION OF SEDIMENTS IN DETENTION POND

Tarmizi Ismail^{1*}, Mazlina Alang Othman², Abu Bakar Fadzil¹, Sobri bin Harun¹, Zaitul Marlizawati Zainuddin³

¹ Department of Hydraulics and Hydrology, Faculty of Civil Engineering, Universiti Teknologi Malaysia, 81310 Skudai, Johor, Malaysia

^{2,3} Former Postgraduate students, Faculty of Civil Engineering, Universiti Teknologi Malaysia, 81310 Skudai, Johor, Malaysia

Hunny

*Corresponding author: tarmiziismail@utm.my

Abstract: Suspended sediment is the pollutant of primary concern to the urban rivers that results in adverse environmental and economical effect. Detention pond may become the structure that can be indirectly used to remove a portion of suspended sediment. Although the ponds were initially designed to control the increased quantity of runoff associated with impervious areas in the urban landscape, the ponds have been increasingly used to reduce the concentration of contaminants in the runoff. Experiments on deposition of sediments in detention pond and other related aspects such as sediment concentration dispersion and efficiency of the pond were investigated in this study. The kaolin concentration (150 mg/L) has been used as a cohesive sediment material and the range of the discharge is from 0.006 m³/s to 0.016 m³/s. For horizontal distribution, as the diameter of sediment particle is 0.013 mm and particle settling velocity, $\omega_s = 0.8 \times 10^{-4}$ m/s, the shear flows and settling velocities give an effect of sediment concentration in the detention pond. As the time increases, the sediment concentration decays. The vertical distribution of suspended sediment concentration is uniform according to the small Rouse number at each point. The deposition rates depend on inlet velocity of the pond, an increase from 4.725×10^{-3} g/sec m² in inlet area to 5.715×10^{-3} g/sec m² at outlet area. The sediment trap efficiencies of the model is 20 % which is less than the sediment trap efficiency of the prototype due to only cohesive sediment material was used in this experiment

Keywords: *sediment ; detention pond ; deposition ; sediment dispersion*

1.0 Introduction

In this era of modernization and industrialization, environmental issues often take a back seat in order to pave way for rapid development and urbanization. Water pollution is becoming a bigger problem due to rapid urbanization. It affects the community health status as well as has long term

effects due to environmental hazard. One of a problem related to water pollution is suspended and bedded sediments. Detention ponds have become one of the more popular means of removing some portion of the sediment by stormwater prior to final discharge.

Detention ponds and constructed wetlands have been used for decades to retain stormwater runoff from both urban and agricultural areas. The ponds operate by detaining the storm water for a period of hours or days while releasing the water to receiving streams and lakes. Although the ponds were initially designed to control the increased quantity of runoff associated with impervious areas in the urban landscape, the ponds have been increasingly used to reduce the concentration of contaminants in the runoff (Wu et al. 1996; Comings et al. 2000; Heitz et al. 2000; Mallin et al. 2002; Harrell and Ranjithan 2003; Revitt et al. 2004). Moreover, the detention ponds and constructed wetlands have been found to be advantageous in the clean up of large volumes of waters contaminated with low levels of trace elements (Lundberg et al. 1999; Qian et al. 1999; Farm 2002; Taebi and Droste 2004; Casey et al. 2005). The extended residence time in detention pond provides greater opportunity for solid constituent such as suspended sediment primarily removed by settling.

Deposition of sediment is among the physical functions of detention ponds. Sediment transport in these ponds in general and particle retention in particular depend on a number of hydraulic and sedimentologic parameters and controls, such as flow rate and flow velocity, particle size, diffusive processes like molecular and turbulent diffusion as well as shear flow dispersion, inflow concentration, water temperature and further mixing agents like wind shear and the presence of vegetation. Compared to sediment transport in open channel flow, the situation typically encountered in detention ponds is characterized by much lower flow velocities, frequently placing the flow in the transitional regime between laminar and turbulent, which, in turn, has a pronounced effect on both the velocity distribution and the strength of mixing processes. A study about deposition of sediment had been investigated from several researchers in Malaysia. Recent studies (Ab. Ghani *et al.* 2000; Kassim *et al.* 2004; Kassim, 2005) in several major cities in Malaysia confirmed the presence of loose deposited beds of non-cohesive sediments in rigid open storm drains with average sediment sizes between 0.35mm and 2.40 mm. Kassim (2005) carried out field data collection along Raja River drainage system to identify the trend of sediment depositions in open storm drain.

The study on detention ponds performance according to water quantity and quality showed little consistency. However, better understanding of how wet detention pond performs with regard to water quality and quantity is essential for improving stormwater drainage management practices in tropical urban areas.

To achieve the desired water quality criteria, the pond should have an appropriate volume, storage detention time, and contaminant removal characteristics. While the hydrologic design of detention ponds has been well established, the design criteria which are based on the control of peak flows may not provide desired water quality treatment of storm water runoff. With improved understanding sediment deposition in detention pond, the design can be optimized and the use of the current design guidelines can be made more efficient

In this study, laboratory experiments were conducted to characterize the deposition of suspended sediment in detention ponds. The objective of this experiment is to study a pattern of sediment concentration dispersion in vertically and horizontally when sediment enters the detention pond. Deposition rate and efficiency of the pond were also assessed in this experiment.

The vertical distribution of suspended sediment concentration can be expressed by the following Rouse (1938) equation which is

$$\frac{C}{C_a} = \left[\frac{h-z}{z} \times \frac{a}{h-a} \right]^{\frac{\omega_s}{ku_*}}$$

where C_a is the reference concentration (g/L) at the distance a above the bed (m), h is water depth (m) and ω_s/ku_* is the Rouse number of suspended sediments, which determines the degree of uniformity of suspension. The smaller the Rouse number, the more uniform the suspension is.

Mehta and Partheniades (1973) performed laboratory studies on the depositional behavior of cohesive sediment and found that deposition is controlled by the bed shear stress, turbulence processes in the zone near the bed, settling velocity, type of sediment, depth of flow, suspension concentration and ionic constitution of the suspending fluid (also summarized in Hayter et al., 1999). Deposition rate (in a one dimension vertical context) can generally be computed as (Krone, 1962b):

$$D = \left(1 - \frac{\tau_b}{\tau_{cd}} \right) \omega_s C$$

In which

τ_b = applied bed shear stress

τ_{cd} = critical bed shear stress for deposition

C = suspended sediment concentration in the water column

ω_s = particle settling velocity

Previous studies have estimated the critical shear stress for deposition to range between 0.06 and 1.1 N/m², depending on the sediment type, size and concentration. Mehta and Partheniades (1975) found that $\tau_{cd} = 0.15$ N/m² for kaolinite in distilled water.

One of the most informative parameters of a reservoir or pond is a sediment trap efficiency (Heinemann, 1981). Sediment trap efficiency of a pond or reservoir is the fraction of the sediment that enters the pond and which is deposited in the pond. A good knowledge about the sediment trap efficiency is crucial for several reasons. Reservoirs or ponds that are constructed for water supply or for controlling floods need to maintain their capacity for a long time. Sediment deposition therefore needs to be minimized and this can be achieved by reducing the sediment input to the reservoir or pond, or by constructing the reservoirs so that they have low sediment trap efficiency. On the other hand, detention ponds that are constructed primarily to keep the sediment out of rivers in a water quality programme (e.g. Ferguson, 1981; Mielke, 1985; Harbor *et al.*, 1997), need to have high sediment trap efficiency. Sediment trap efficiency is also important when sediment deposits in ponds or reservoirs are used to assess sediment yields (e.g. Neil and Mazari, 1993; Foster, 1995; White *et al.*, 1996; Verstraeten and Poesen, 1999). The efficiency, η of a sedimentation detention pond is measured as the proportion of the incoming sediment load retained in the trap:

$$\eta = \left(\frac{Load_{in} - Load_{out}}{Load_{in}} \right) \times 100$$

Where $Load_{in}$ and $Load_{out}$ are the total incoming and outgoing sediment loads obtained from the pond of the products of the flow and concentration ordinates.

2.0 Experimental Apparatus And Procedure

2.1 Scaling in physical modeling

In this experiment, model is assumed as a distorted model which has different horizontal and vertical spaces due to space limitation. Model – prototype similarity is performed with a Froude similitude for a distorted model and the laboratory system characteristics are shown in Table 1.

Table 1: Model Scale Properties

Parameter	Unit	Scale ratio with Froude Law (for distorted model)	Actual pond	Model scale
<i>Geometric properties</i>				
Depth	m	$Y_R = 1/4$	2 m	0.5 m
Length	m	$L_R = 1/50$	P = 150 m L = 50 m	3 m 1 m
<i>Kinematic properties</i>				
Discharge	m ³ /s	$Y_R^{3/2} L_R$	33.37 m ³ /s	0.08 m ³ /s
Time	s	$\frac{L_R}{\sqrt{Y_R}}$	2 hour storm duration	5 min

2.2 Experimental Installation

The experimental studies were carried out at the Hydraulics and Hydrology Laboratory, Faculty of Civil Engineering, Universiti Teknologi Malaysia. A cylindrical mixing tank used for sediment and water mixture, which also supply the turbid water inflow during experimental run. Turbid water was injected into an 11 m long transparent flume, 30 cm wide, and 38 cm high with a bottom slope of 0.002 and flowing into a pond of size 3m x 1m x 1m where the study of sediment laden was be carried out in this area. The schematic representation of the experimental setup is shown in Figure 1.

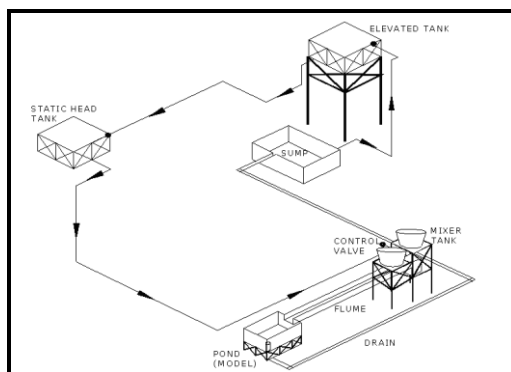

Figure 1: Schematic representation of experimental setup

2.3 Experimental Procedure

This experiment was carried out to study a distribution of sediment when sediment laden into a pond. In any event, the controlled variables in this experiment were designed as follows:

- a) Concentration of kaolin is 150 mg/L
- b) Duration of flow for most of the runs was conducted for a period of approximately 60 minute including 5 minutes duration of injection of sediment. 5 min duration of injection represents 2 hour storm duration and 60 min duration of the run represent 24 hours flow.
- c) Discharges were set to 0.006, 0.010, 0.014 and 0.016 m³/s.

The above conditions were selected not only for simplification, but also to create realistic conditions that would be similar to natural condition flows in terms of sediment concentrations and flow velocities. Figure 2 illustrated the experiment setup and a following procedure was used to investigate a sediment deposition pattern in this experiment.

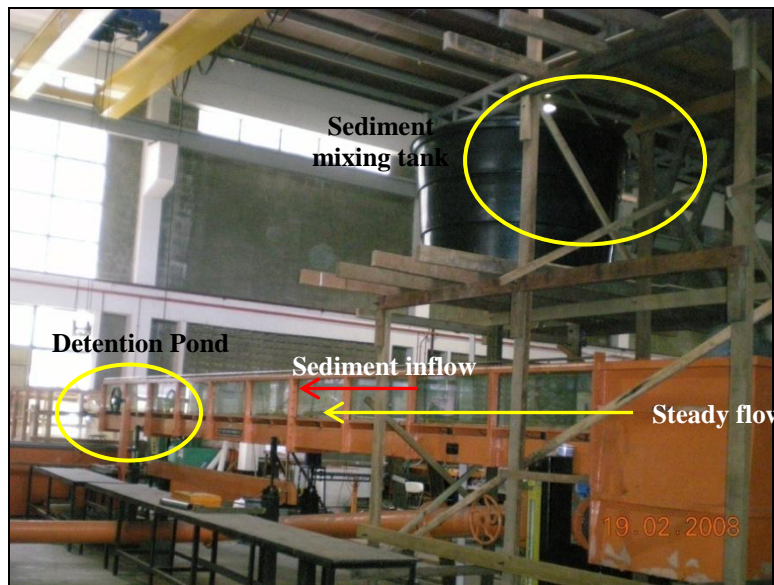

Figure 2: Experimental setup

Procedure:

- 1) The control valve was opened as flow supplied to the flume. Steady-state flow was studied, as the most simple and easily characterized flow regime
- 2) An amount of 2 kg of kaolin was thoroughly mixed with 300 gallon of water in sediment mixing tank. Kaolin is used as a sediment material and supplied by Cheras Kaolin Industries Sdn Bhd, Kuala Lumpur. It was sieved through 60 μm and added as slurry of known concentration directly into the flow.
- 3) Concentration of sediment in the flume was prepared at approximately 150 mg/L and the sediment flow was controlled by a valve at sediment mixing tank.
- 4) The sample was introduced into a flume where an injection points was located downstream of the sediment tank. Inflow discharge and sediment concentration were kept constant during each experimental process.
- 5) Trajectories of the sediment were investigated along a flume and when the sediment laden into the pond. Sediment concentration was measured at several points as shown in Figure 4.
- 6) Siphon-type suction tube was used to collect sample for sediment concentration measurement. These siphon tubes were located at depth 0.2, 0.6 and 0.8 of water elevation at predetermined points in the pond. Samples were collected at 3, 7, 30 and 60 min for each run. Concentrations associated with each sample were determined from filtration/drying method (TSS experiment).
- 7) After 5 min injection of sediment, the flow supply was turned to normal flow at $0.003 \text{ m}^3/\text{s}$ and after 60 min as schematically shown in Figure 3; the flow was stopped by closing control valve. Deposited sediment in gridded areas in the pond was collected and dried for further analysis.

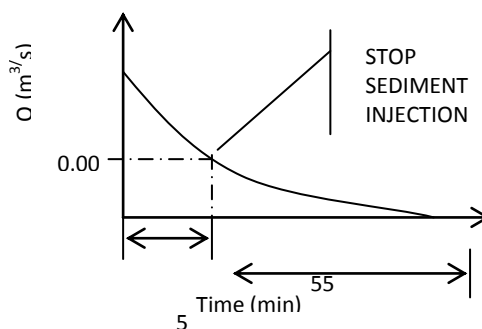

Figure 3: Relationship between Time and Discharge for Sediment Injection

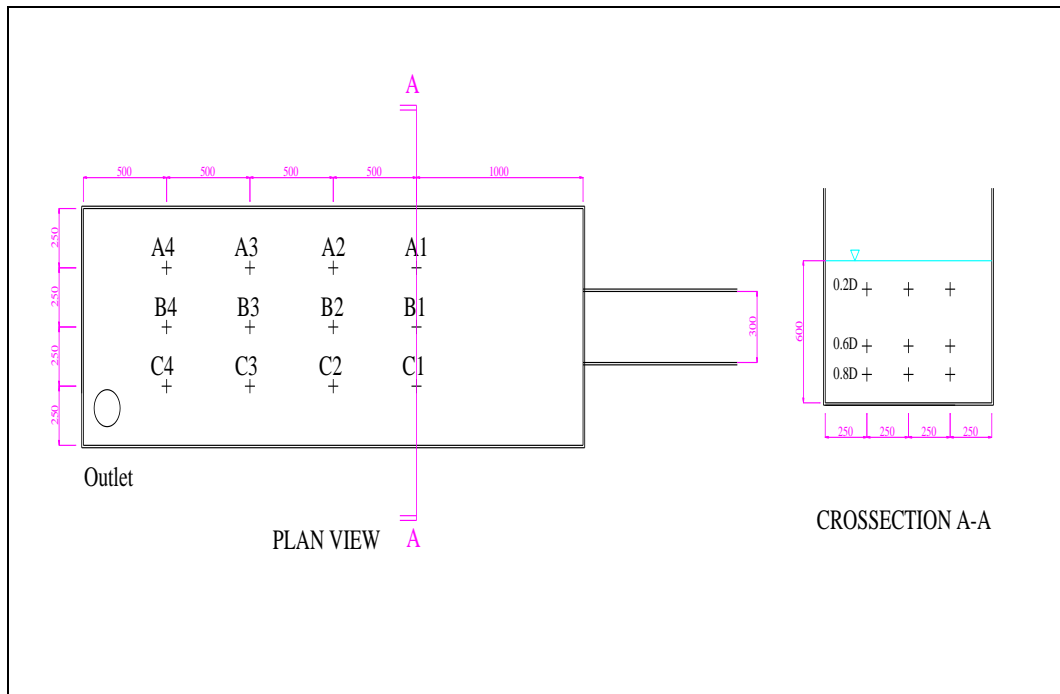

Figure 4: Location of Point Sampling

2.4 Hydrometer Analysis

Hydrometer analysis was carried out to calculate settling velocity, specific gravity and also provides an approximate particle-size distribution. From Hydrometer analysis, the value of settling velocity of kaolin used in this study is 0.8×10^{-4} m/s, specific gravity is 2.67. Particle-size distribution curves for kaolin in Figure 5 shows that median particle diameter is 0.013 mm.

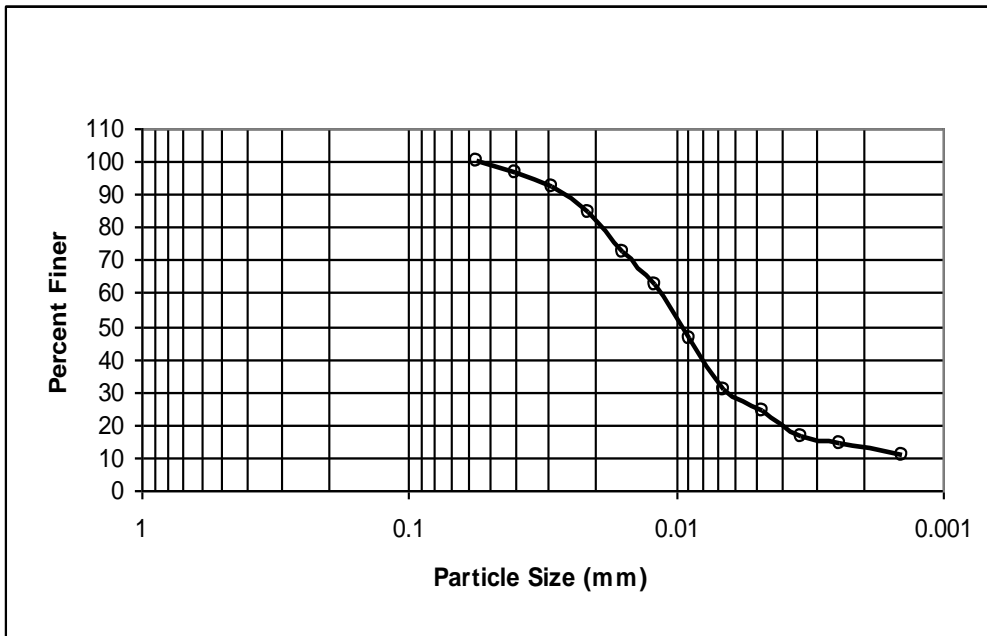

Figure 5: Particle size distributions for Kaolin

3.0 Result And Analysis

3.1 Horizontal Distribution of Sediment

A horizontal distribution of sediment in the pond was analyzed by using SURFER software which is a computer graphics system for displaying data in the form of colored plots.

a) For $Q = 0.016 \text{ m}^3/\text{s}$

Figure 6 shows a distribution of sediment concentration at 3 min, 7 min, 30 min and 60 min for maximum discharge $0.016 \text{ m}^3/\text{s}$. At 3 min after sediment injection, a high value of sediment concentration tends to concentrate at location 2m from inlet point. At normal flow condition, a value of sediment concentration scattered along a pond and for 30 min and 60 min after sediment injection, sediment concentration decrease with a value less than 35 mg/L . This situation occurs when a small particles of sediment bind together to form larger

flocs. The flocs may grow when they collide with other particles or other flocs and they will deposit at the bottom of the pond.

b) For $Q = 0.014 \text{ m}^3/\text{s}$

A horizontal distribution of sediment concentration for $Q = 0.014 \text{ m}^3/\text{s}$ at 3 min as shown in Figure 7 give a similar result with $Q = 0.016 \text{ m}^3/\text{s}$ but sediment concentration tends to concentrate at 2m to 2.5 m from inlet point. In this area, a maximum value of concentration is 100 mg/L. At 7 min, a concentration decrease towards downstream direction with a value 85 mg/L to 45 mg/L. At normal flow after 30 min and 60 min, a large amount of the sediment already deposited.

c) For $Q = 0.010 \text{ m}^3/\text{s}$

A horizontal distribution of sediment concentration for $Q = 0.014 \text{ m}^3/\text{s}$ is shown in Figure 8. After 7 min, the concentration is still high especially at inlet area and it decays toward downstream direction. Similarly, for condition 1 and condition 2, sediment concentration at 30 min and 60 min decrease with a value less than 35 mg/L due to flocculation process.

d) For $Q = 0.006 \text{ m}^3/\text{s}$

Figure 9 shows a distribution of sediment concentration at 3 min, 7 min, 30 min and 60 min for minimum discharge $0.006 \text{ m}^3/\text{s}$. Sediment concentration at 3 min, 7 min and 30 min gives a high values along a pond cause by low velocity. For 60 min condition, the concentration much lower due to flocculation process and all the sediment deposited at the bottom of the pond.

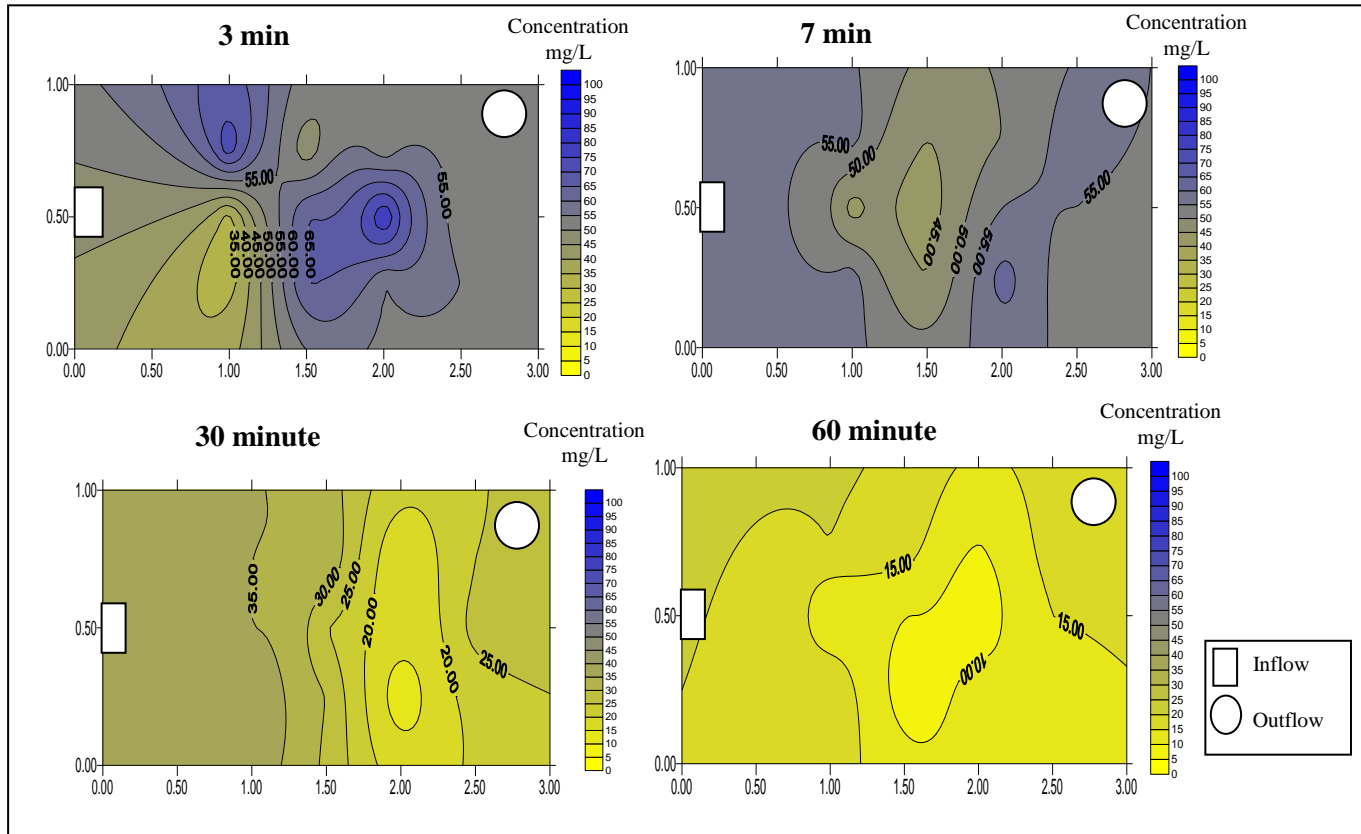

Figure 6: Horizontal Sediment Concentration for $Q = 0.016 \text{ m}^3/\text{s}$

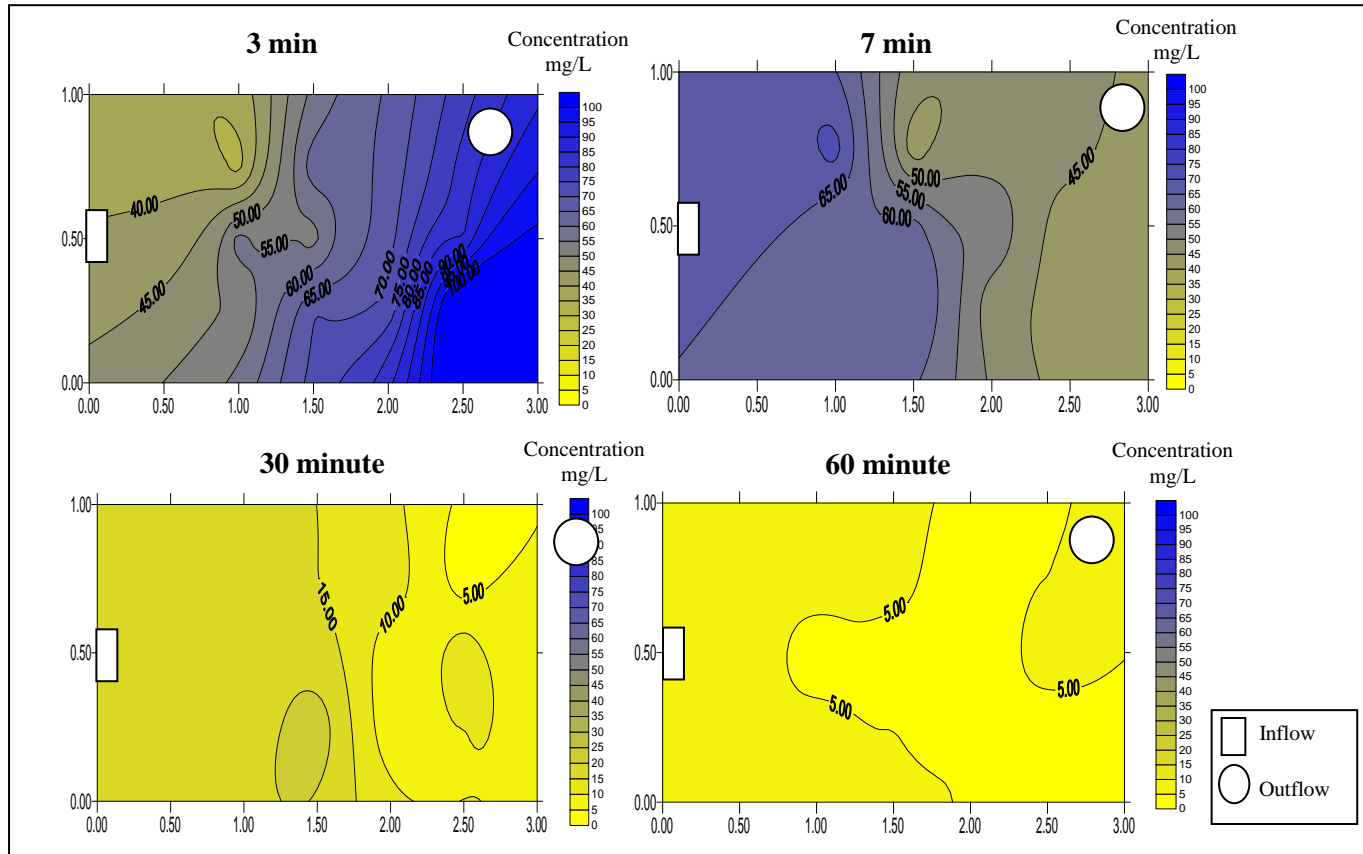

Figure 7: Horizontal Sediment Concentration for $Q = 0.014 \text{ m}^3/\text{s}$

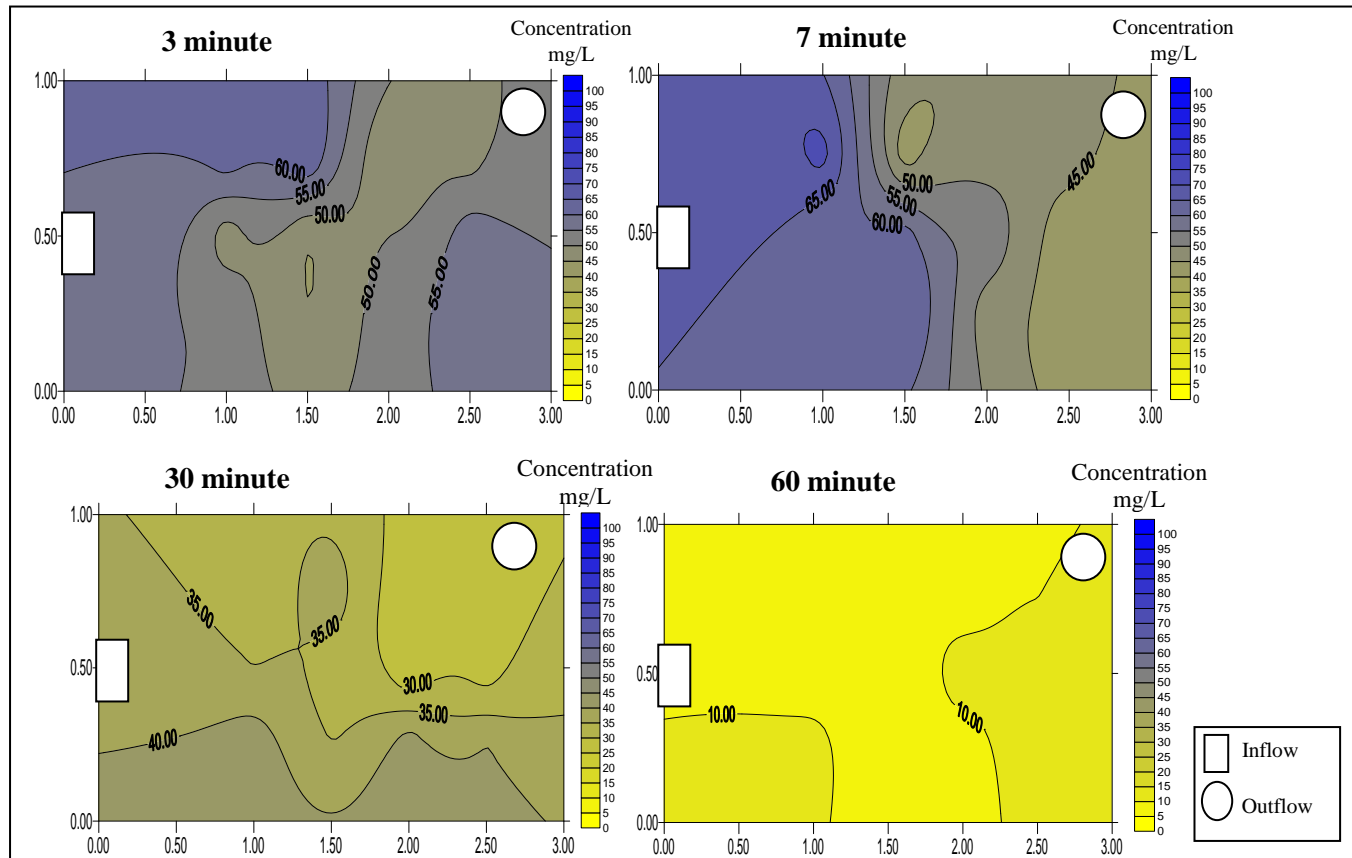

Figure 8: Horizontal Sediment Concentration for $Q = 0.010 \text{ m}^3/\text{s}$

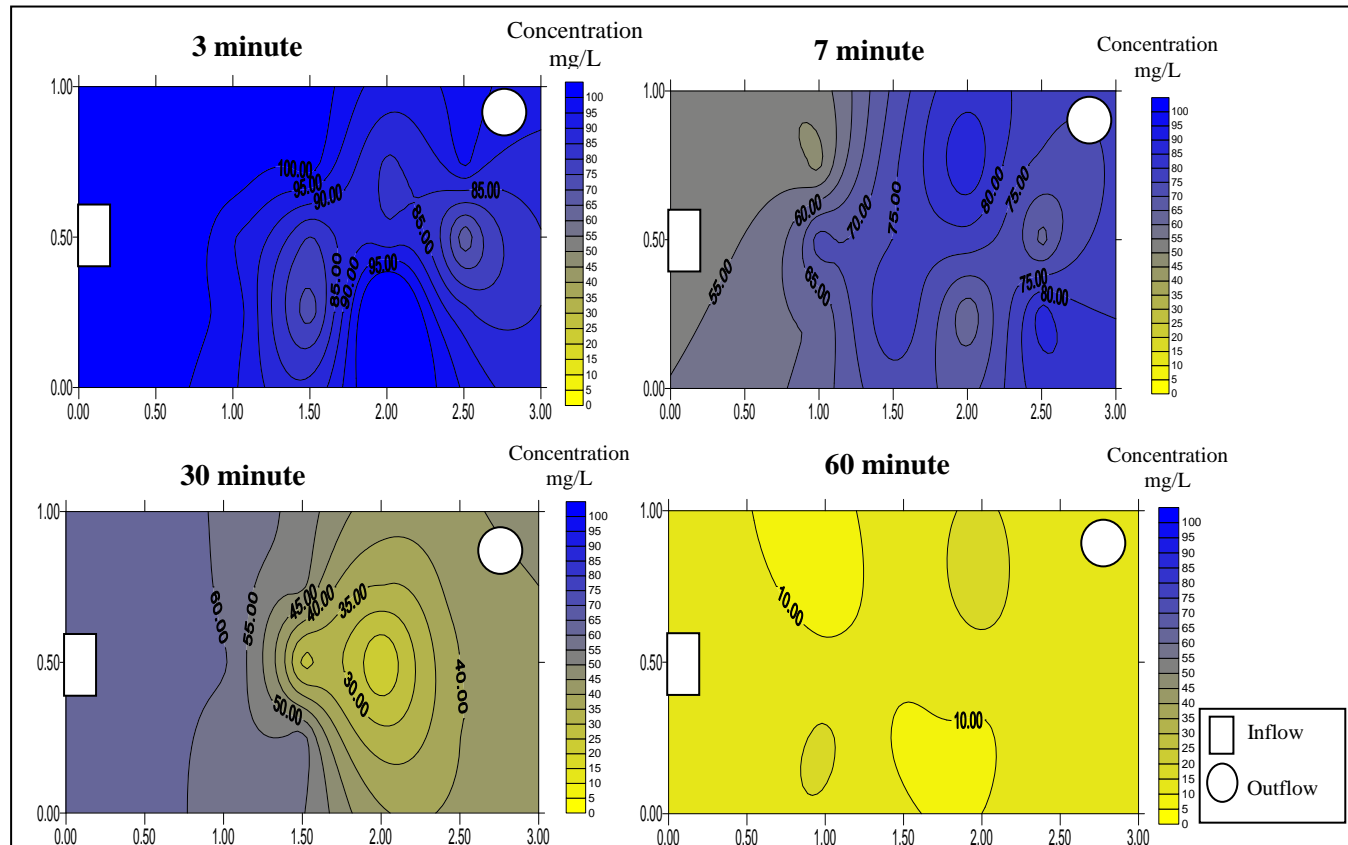

Figure 9: Horizontal Sediment Concentration for $Q = 0.006 \text{ m}^3/\text{s}$

3.1.1 Effect of Flocculation

In the case of cohesive sediment, the effect of flocculation makes settling velocity a function of sediment concentration distribution. Because of turbulence holds the suspended and wash load in suspension, turbulence becomes one of the basic parameters in the formation of flocs (Van Leussen, 1994). Turbulence increases the number of collisions between the particles, thus resulting in larger flocs and larger settling velocities. Hunt (1980) concludes that processes associated with the collision mechanism are depending on the size of the particles. For particles less than $4\mu\text{m}$, the *Brownian motion* due to the thermal energy of the flowing medium is dominant while for particle large than $10\mu\text{m}$, the shear flow and differential settling velocities are important. In this experiment, diameter of sediment particle is 0.013 mm so shear flows and settling velocities give an effect of sediment concentration in detention pond.

3.1.2 Effect of Time

As measured by Krone (1962), suspended sediment concentration will decay with time for cohesive sediment. Concentration of sediment in this experiment also decays with increasing a time. Figure 10 shows mean sediment concentration for each flow decays with increasing in time from 3 min up to 60 min.

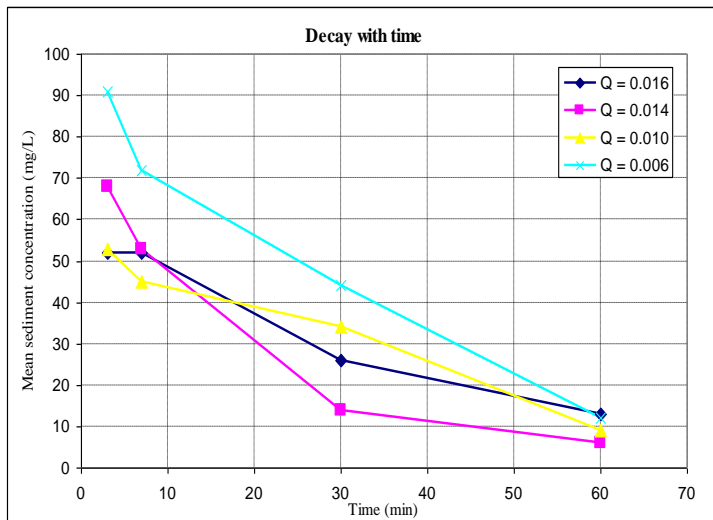

Figure 10 : Relationship between Sediment Concentration and Time

3.2 Vertical Distribution of Sediment Concentration

The traditional diffusion theory yields that in open channel flow the sediment concentration always gradually decreases from bed to the water surface. Using the experimental result shows in that table, value of sediment concentration at reference location is uniform from water surface to bottom of the pond. Thorn produce a profile of velocity and concentration of sediment grains with diameters in two size range (in mm) as shown in Figure 11. As a size of sediment in this experiment is 0.013 mm, that figure proves the value of sediment concentration in this experiment should be uniform through a water column.

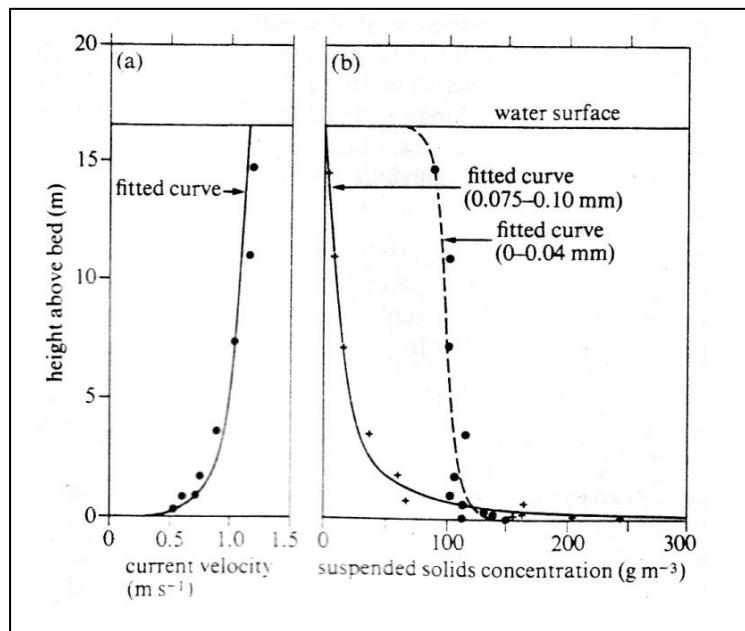

Figure 11: Profiles of Velocity and Concentration of Sediment Grains with Diameters in Two Size Range (in mm) (source: Thorn, 1975)

The Rouse (1938) solution in general terms also demonstrates that very fine sediment is nearly uniformly distributed vertically in the cross-section. The following equation shows a value of uniformity of suspension:

$$\frac{C}{C_a} = \left[\frac{h-z}{z} \times \frac{a}{h-a} \right]^{\frac{\omega_s}{ku}}$$

where C_a is the reference concentration (g/L) at the distance a above the bed (m), h is water depth (m) and w_o/KU_* is the Rouse number of suspended sediments, which determines the degree of uniformity of suspension. Taking the natural logarithm of both sides of the Rouse equation yields:

$$\ln C = \ln C_a + z^* \ln \left[\frac{h-z}{z} \times \frac{a}{h-a} \right] \text{ which can be rewritten as ;}$$

$$\ln C = A + z^* \ln \left[\frac{h-z}{z} \right]$$

where the Rouse number $z^* = \omega_o/KU_*$ and A does not vary with z . A linear regression of the natural logarithm $\ln C$ with $\ln \left[\frac{h-z}{z} \right]$ yields a line with a slope that is the Rouse number $z^* = \omega_o/KU_*$. The smaller the Rouse number, the more uniform the suspension is. A value of vertical sediment concentration in this experiment was plotted on the horizontal scale versus the variable y/d on the vertical scale using log-log axis. As mention before, the Rouse solution should plot as straight line on log-log axes and Rouse number is a value if line slope. Figure 12 shows the value of line slope for every point in each condition are small.

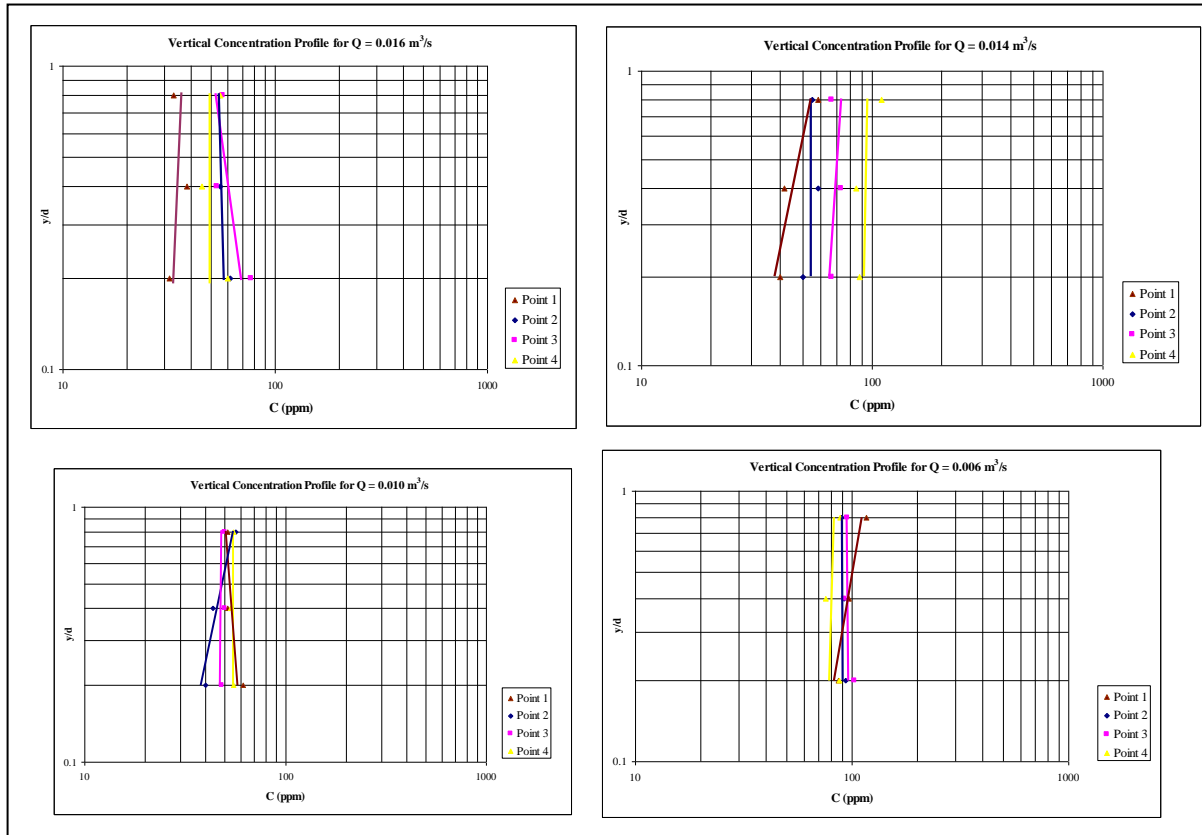

Figure 12: Vertical Distribution Profile

3.2.1 Deposition Rate

Concentration of sediment in the water column is important and all of these factors are combined into a single relationship, rate of sediment deposition. To relate a deposition pattern to the downstream direction, graphs of mean values of deposition rate verses distance from pond entrance are plotted. Typical profiles of the deposition rate for each condition are shown in Figure 13. For flow discharge $0.016 \text{ m}^3/\text{s}$ and $0.014 \text{ m}^3/\text{s}$, the rate of deposition increase toward the downstream direction. It is because a velocity of the water flow decreases from inlet point to the downstream direction. For condition 1, maximum value of deposition rate occurs at 2 m from inlet due to high concentration of sediment in that area. It is different with condition 2 where a high value of deposition rate occurs at 2.5 m from inlet point and located close to outlet area. For low flow condition with discharge $0.010 \text{ m}^3/\text{s}$ and $0.006 \text{ m}^3/\text{s}$, deposition pattern are different with condition 1 and condition 2. With a low value of discharge, deposition rate is almost similar at every point in the pond and a highest deposition rate occurs at location 1m from inlet point. From that result, the rate of deposition depends primarily on velocity in the pond. For velocity at condition 1 and 2 which is greater than velocity at condition 3 and 4, high deposition rate occur at downstream area. For condition 3 and 4, high deposition rate occurs at inlet area.

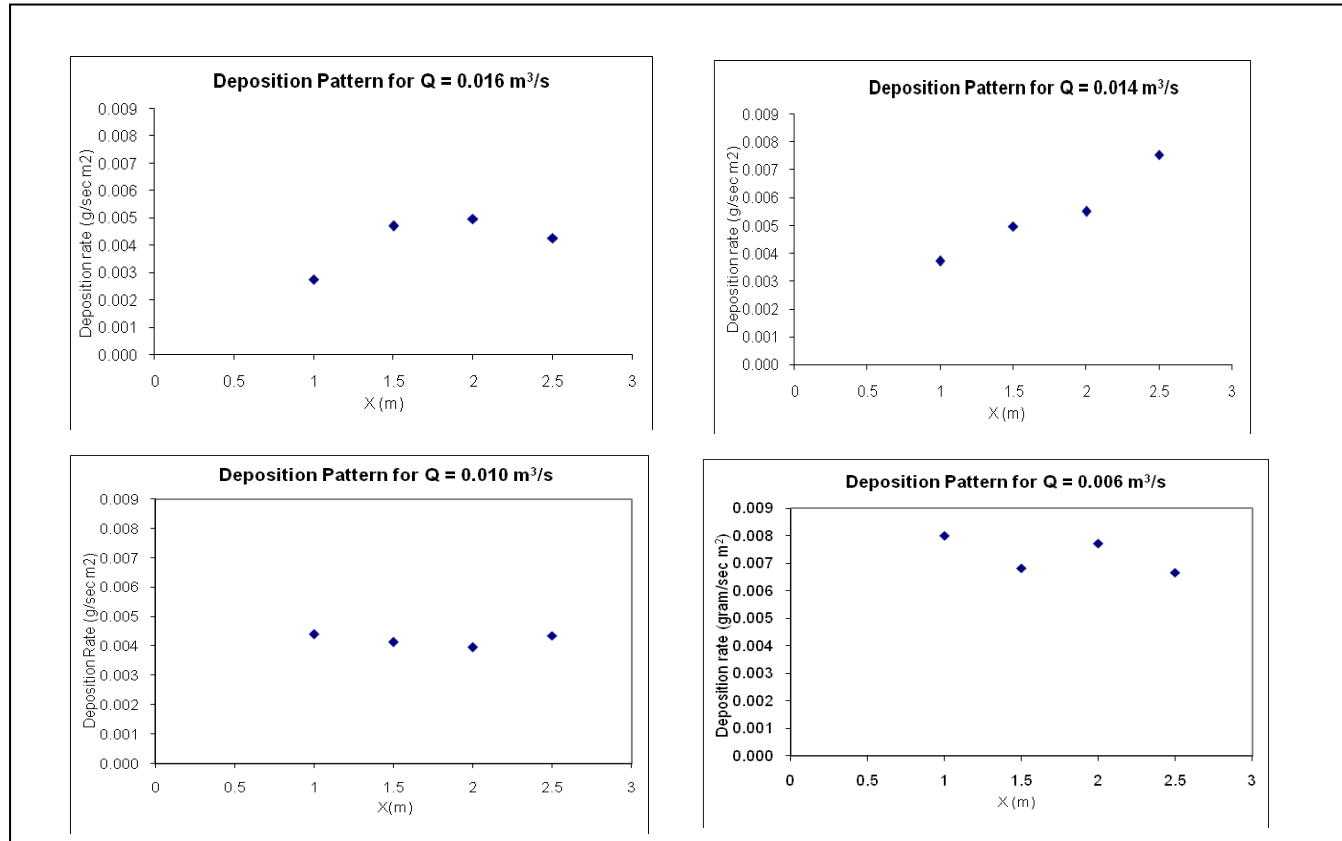

Figure 13: Deposition rate for Various Flow Conditions

3.3 Efficiency of the Pond

According to design of the pond, sediment trap efficiency of the model is less than sediment trap efficiency of the prototype. This is due to actual condition at site whereas the type of sediment available varies from cohesive soil to non-cohesive soil. For this experiment, it focuses on cohesive sediment only. The type of sediment chosen for this experiment affects the result of efficiency of the experiment. The result from experiment also shows that trap efficiency is related to flow discharge. The results obtain from three sets of experiments shows higher trap efficiency for high discharge of flow into model.

Table 2: Pond Trap Efficiency

Condition	Discharge (m ³ /s)	Load _{in} - Loan _{out}	Load _{in}	Trap efficiency %
1	0.006	50	380	20
2	0.014	53	340	16
4	0.016	67.5	340	13

3.0 Conclusion

The conclusion should be drawn from this study are as follows:

1. For horizontal distribution of sediment concentration, shear flows and settling velocities give an effect of sediment concentration in detention pond for cohesive sediment. Effect of flocculation makes settling velocity a function of sediment concentration distribution
2. Concentration of sediment in this experiment also decays with increasing of time.
3. For very fine sediment, concentration is uniformly distributed on vertical direction in detention pond according to the small value of the Rouse number.
4. The rate of deposition depends on velocity which enters into the pond. For velocity at condition 1 and 2 which is greater than velocity at condition 3 and 4, high deposition rate occur at downstream area. For condition 3 and 4, high deposition rate occurs at inlet area.

5. Sediment trap efficiency of the model is less than sediment trap efficiency of the prototype due to a homogeneous sediment size chosen for this experiment

4.0 Recommendation for Future Work

The following section highlights some of the recommendation that could be included in future research of sediment deposition in detention pond

1. The laboratory investigations performed in this research should be repeated for velocity distribution in detention pond.
2. There are two types of sediment material which is cohesive and non-cohesive sediment. As cohesive sediment already studied in this experiment, similar investigation should be performed using non-cohesive sediment.
3. For a better understanding on the behavior of sediment in detention pond, experimental data from this study may be calibrated with data obtained from the field
4. Regression analysis between discharge, time, and size of the pond will be important step to understand the detention phenomena.
5. In the case of cohesive sediment, the effect of flocculation makes settling velocity a function of sediment concentration distribution. Study about flocculation should give additional knowledge in relation between deposition and concentration of sediment in detention pond.
6. To get a better result regarding to sediment trap efficiency of detention pond model, different sizes of sediment or combination should be used.

References

- Ab Ghani, A., Zakaria, N.Z., Kassim, M., and Ahmad Nasir, B. (2000). Sediment Size Characteristic of Urban Drain in Malaysia cities. *Urban Water*. 2(4), 335-341
- Amat Sairin Demun, 1997. *Hidraulik Saluran Terbuka Dengan Penggunaan Komputer*, Universiti Teknologi Malaysia. pp325-349.
- Casey, R. E., Shaw, A. N., Massal, L. R., and Snodgrass, J. W. (2005). Multimedia Evaluation of Trace Metal Distribution within Stormwater Retention Ponds in Suburban Maryland, USA." *Bulletin Environ. Contaminant Toxicol.*, 74, 273–280
- Chih Ted Yang, (1996). *Sediment Transport : Theory and Practice*. McGraw-Hill Book Co. Singapore Pp 1-35
- Chin Yao Sheng (2006). *Numerical Simulation of Sediment Transport in Open Channel*. Bachelor of Civil Engineering. Thesis. Universiti Teknologi Malaysia, Skudai.
- Comings, K. J., Booth, D. B., and Horner, R. R. (2000). Stormwater Pollutant Removal by Two Wet Ponds in Bellevue, Washington. *Journal of Environment Engineering*, 126(4), 321–330
- Department of Irrigation and Drainage (2000). *Urban Stormwater Management Manual*, Malaysia
- Farm, C. (2002). Metal Sorption to Natural Filter Substrates for Stormwater Treatment-Column Studies. *Science Total Environment.*, 298(1–3), 17–24.
- Harrell, L. J., and Ranjithan, S. R.(2003). Detention Pond Design and Land Use Planning for Watershed Management. *Journal Water Resources. Plan. Manage.*, 129(2), 98–106
- Heitz, L. F., Khosrowpanah, S., and Nelson, J. (2000). Sizing of Surface Water Runoff Detention Ponds for Water Quality Improvement. *Journal. Am. Water Resource. Assoc.*, 36(3), 541–548.
- Hunt, J.R., (1980). Prediction of oceanic particle size distributions from coagulation and sedimentation mechanisms. In: Kavanaugh, M.C. and Leckie, J.O., Editors, 1980. *Particulates in Water*, American Chemical Society, Washington, DC, pp. 243–257
- Kamphuis, J.W., and K.R. Hall (1983). Cohesive Material Erosion by Unidirectional Current. *Journal of Hydraulic Engineering*, vol. 109, no. 1, January, pp. 49- 61.
- Kassim, M. (2005). *Sediment Deposition in a Rigid Monsoon Drain: A Case Study of Raja River*, Alor Setar. Msc Thesis, Universiti Sains Malaysia
- Kassim, M., Ab. Ghani, A., Abdullah, R. and Zakaria, N.A. (2004). Prediction of Sediment Deposition in Raja River Concrete Drainage System: Sewer Networks and Processes within Urban Water System, *International Water Association (IWA)*, pp.59-65.

- Krone, R.B. (1962). *Flume Studies of the Transport of Sediment in Estuarial Shoaling Processes*, Technical Report, Hydraulic Engineering Laboratory, University of California, Berkeley California.
- Lundberg, K., Carling, M., and Lindmark, P. (1999). Treatment of Highway Runoff: A Study of Three Detention Ponds. *Science Total Environment*. 235, 363–365.
- Mehta, A.J., and E. Partheniades (1973). Depositional Behavior of Cohesive Sediments, *Tech report No. 16*, Univ. of Florida, Gainesville, Florida.
- Qian, J. H., Zayed, A., Zhu, Y. L., Yu, M., and Terry, N. (1999). Phytoaccumulation of Trace Elements by Wetland Plants. III: Uptake and Accumulation of Ten Trace Elements by Twelve Plant Species. *Journal Environment Quality*, 28(5), 1448–1455
- Revitt, D. M., Shutes, R. B. E., Jones, R. H., Forshaw, M., and Winter, B. (2004). The Performances of Vegetative Treatment Systems for Highway Runoff During Dry and Wet Conditions. *Science Total Environment*. 334(335), 261–270.
- Rouse, H. (1938). *Fluid Mechanics for Hydraulic Engineers*. McGraw-Hill: New York, USA .pp 1-422
- Taebi, A., and Droste, R. L. (2004). Pollution Loads in Urban Runoff and Sanitary Wastewater. *Science Total Environment*., 327(1–3), 175–184.
- Thorn, M.F.C. (1981). Physical Processes of Siltation in Tidal Channels, *Proceedings of the Conference on Hydraulic Modelling Applied to Maritime Engineering Problems*, Institution of Civil Engineers, London, England, 1981, pp. 47-55.
- Vermeyen, T. (1995). *Erosional and Depositional Characteristics of Cohesive Sediments Found in Elephant Butte Reservoir, New Mexico*, Technical Report R-95-15, Water Resources Services, Technical Service Center, Bureau of Reclamation, Denver, CO.
- Van Leussen W., (1994). *Estuarine Macroflots and their Role in Fine-Grained Sediment Transport*. PhD Thesis, University of Utrecht, 488 pp
- Van Rijn, L. (1993). *Principles of Sediment Transport in Rivers, Estuaries and Coastal Seas*, Aqua Publications, The Netherlands.
- Wu, J. S., Holman, R. E., and Dorney, J. R. (1996). Systematic Evaluation of Pollutant Removal by Urban Wet Detention Ponds. *Journal of Environment Engineering*, 122(11), 983–988
- Xiaohai Liu (2007). *3D Numerical Modeling of Hydrodynamics and Sediment Transport in*